



# MIKADO

WINNER



## MIKADO

Flessibilità compositiva.  
Mikado incarna l'essenza stessa della libertà espressiva e creativa: la possibilità di orientare a piacimento le bacchette permette di dare origine a geometrie ortogonali o dinamiche, esplorando soluzioni più rigide o più fluide. L'equilibrio tra la struttura in metallo verniciato e i diffusori è completamente sganciato da ogni vincolo formale. Questa estrema autonomia è la ragione per cui Mikado è stata premiata con il Good Design Award.

Compositional flexibility.  
Mikado embodies the very essence of expressive and creative freedom: the ability to direct the rods freely gives rise to orthogonal or dynamic geometries, exploring more rigid or more fluid solutions. The balance between the painted metal structure and the diffusers is completely free from any formal constraints. This extreme autonomy is the reason why Mikado was awarded the Good Design Award.

Kompositorische Flexibilität.  
Mikado verkörpert die Essenz expressiver und kreativer Freiheit: Die Möglichkeit, die Stäbe nach Belieben auszurichten, erlaubt die Schaffung orthogonaler oder dynamischer Geometrien und die Erforschung starrer oder fließender Lösungen. Das Gleichgewicht zwischen der lackierten Metallstruktur und den Diffusoren ist völlig frei von jeglichen formalen Zwängen. Diese extreme Autonomie ist der Grund, warum Mikado mit dem Good Design Award ausgezeichnet wurde.

Flexibilité de la composition.  
Mikado incarne l'essence même de la liberté d'expression et de création : la capacité d'orienter à volonté les baguettes permet de créer des géométries orthogonales ou dynamiques et d'explorer des solutions rigides ou fluides. L'équilibre entre la structure en métal peint et les diffuseurs élimine toute contrainte formelle. Cette autonomie extrême a valu à Mikado le prix Good design.

# MIKADO

WALL | CEILING LAMP



# MIKADO

WALL | CEILING LAMP

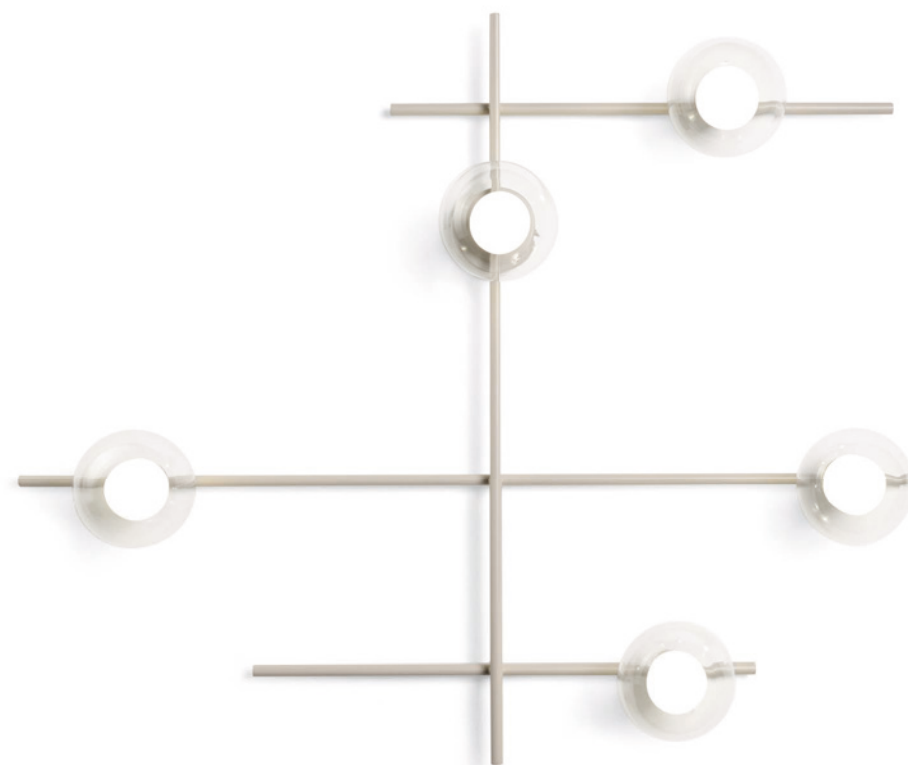
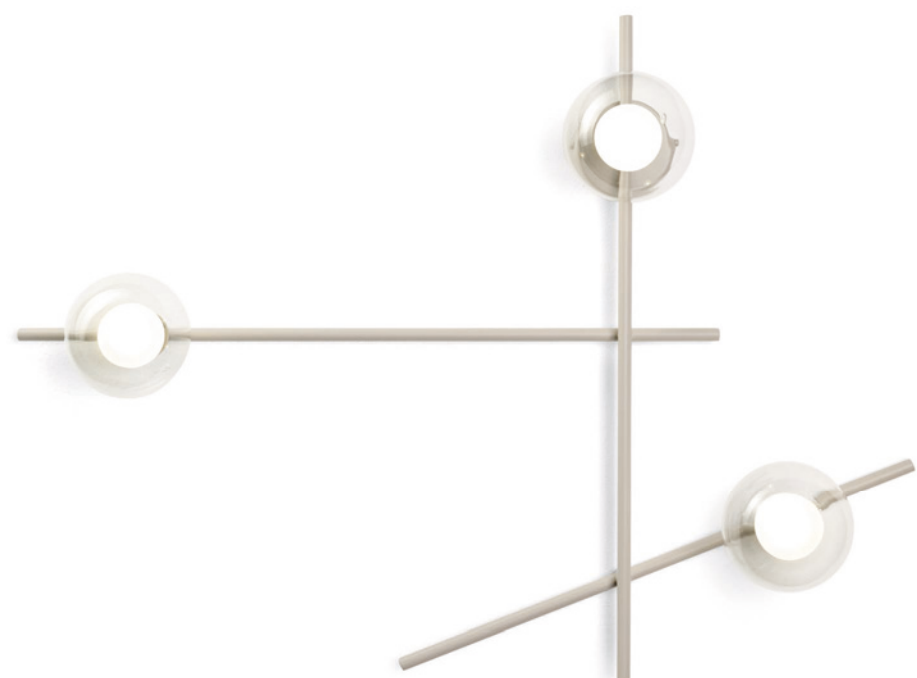
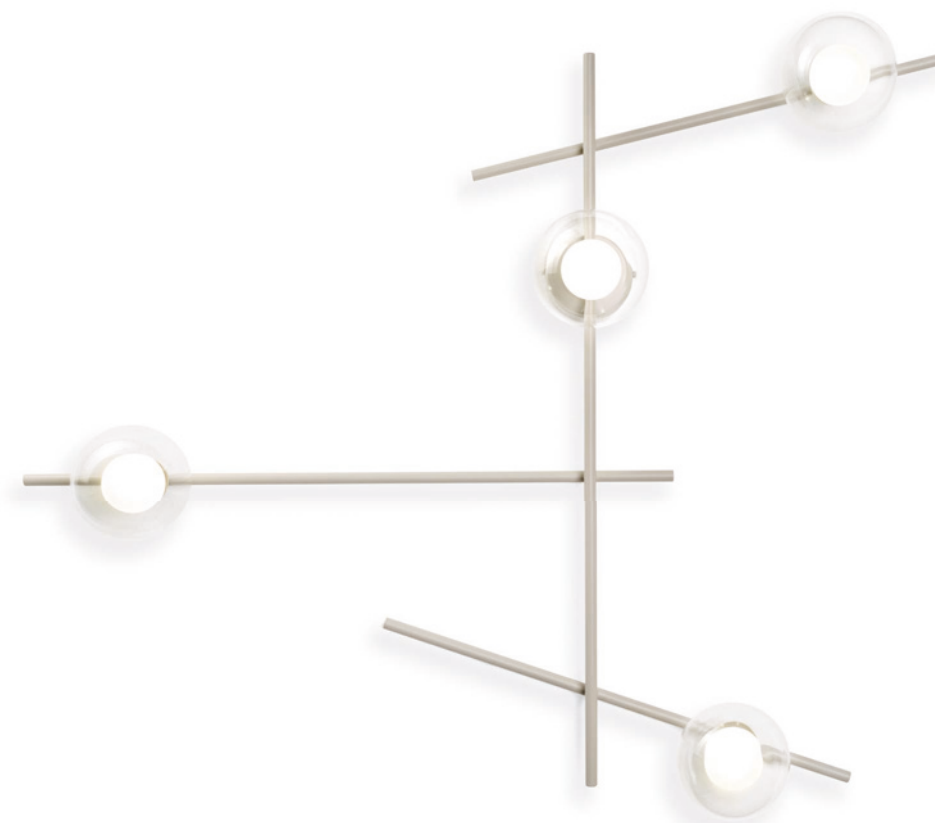

# MIKADO

WALL | CEILING LAMP

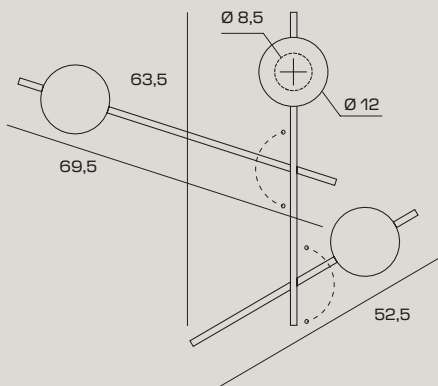

- + Uscita cavo elettrico
- + Power Supply
- + Brennstelle
- + Sortie de câble électrique

Lampada da parete o soffitto con montatura in metallo verniciato a polvere nero o cipria opaco. Diffusore in vetro soffiato bianco latte diametro 12cm o diffusore in vetro borosilicato trasparente esterno e satinato interno, diametro 12 cm. La rotazione dei bracci secondari consente di scegliere la posizione preferita.

Wall or ceiling lamp with matt black or powder-coated metal mount. Milk-white blown glass diffuser (12 cm diameter) or diffuser with transparent borosilicate glass on the outside and satin-finished on the inside (12 cm diameter). The rotation of the secondary arms allows choosing the preferred position.

Wand- oder Deckenleuchte mit mattschwarzem oder cipriafarbenem pulverbeschichtetem Metallgestell. Diffusor aus mundgeblasenem milchweißem Glas, Durchmesser 12 cm, oder Diffusor aus Borosilikatglas, außen transparent und innen satiniert, Durchmesser 12 cm. Die Drehung der Sekundärarme ermöglicht es, die bevorzugte Position zu wählen.

Applique ou plafonnier avec monture en métal revêtu de peinture poudre noire ou rose poudré mat. Diffuseur en verre soufflé blanc laiteux diamètre 12 cm ou diffuseur en verre borosilicate, extérieur transparent et intérieur satiné, diamètre 12 cm. La rotation des bras secondaires permet de modifier la position.

WINNER

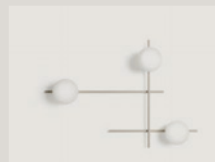
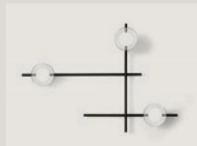
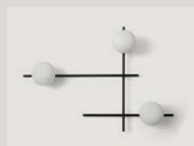

CODE	1744.176	1744.219	1744.373	1744.377
GLASS	● White	○ Transparent	● White	○ Transparent
COLOR	● Black	● Black	● Pink Powder	● Pink Powder

€ INCL VAT (22%)	256,00	265,00	256,00	265,00
€ EXCL VAT	209,84	217,21	209,84	217,21

## LIGHT SOURCE



Source G9 LED | Power 3 x max 10w  
Max bulb size: Ø20xH60mm

