

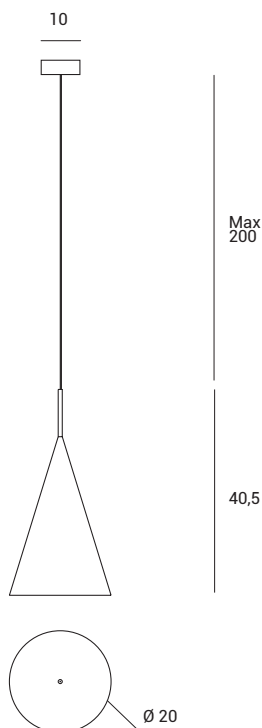

Lampada a sospensione
in metallo verniciato a polvere:
colore esterno nero soft touch,
interno bianco, diametro 20 cm.
Stelo in ottone spazzolato e cavi
di alimentazione altezza 200 cm.

Pendant light in powder coated
metal: soft touch black finish
on the outside, white on the inside,
measuring 20 cm in diameter.
Brushed brass stem and
200 cm. cables.

Pendelleuchte aus
pulverbeschichtetem Metall.
Außen Soft-Touch-Schwarz,
innen Weiß, Durchmesser 20 cm.
Pendelrohr aus gebürstetem
Messing und Stromkabel 200 cm.



SAMOI



Source

E27 LED

Power

1 x max 20w

1744.110

Lampada a sospensione a 3 luci in metallo verniciato a polvere: colore esterno nero soft touch, interno bianco. Stelo in ottone spazzolato. Dotata di Kit di decentramento e cavi di alimentazione altezza 200 cm. È possibile configurare una sospensione mixando le lampade della serie Samoi (1744.108; 1744.109; 1744.110) a fianco un esempio.

3-light suspension lamp made of powder-painted metal: soft-touch black on the outside, white on the inside. Brushed brass rod. With shifting kit and 200 cm long power supply cord. You can configure a suspension by mixing the Samoi series lamps (1744.108; 1744.109; 1744.110) as shown in the example to the side.

Hängeleuchte mit 3 Lichtern aus pulverbeschichtetem Metall: Außenfarbe schwarz soft touch, Innenfarbe weiß. Schaft aus gebürstetem Messing. Mit Dezentralisierungskit und Stromkabeln, Höhe 200 cm. Es kann eine Hängeleuchte konfiguriert werden, indem die Leuchten der Samoi-Serie (1744.108; 1744.109; 1744.110) gemischt werden. Hier ist ein Beispiel.

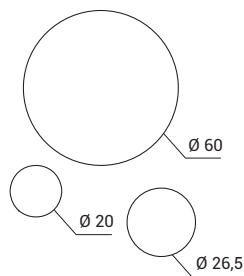
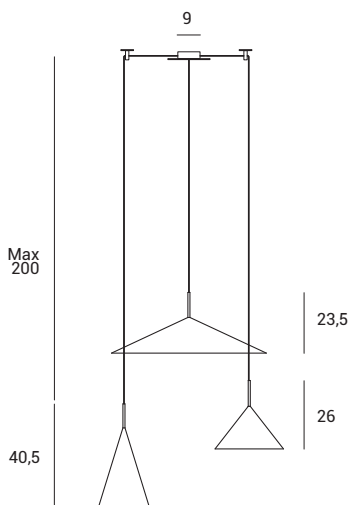

SAMOI



Source

E27 LED

Power



Lampada a sospensione a 4 luci in metallo verniciato a polvere: colore esterno nero soft touch, interno bianco. Stelo in ottone spazzolato. Dotata di Kit di decentramento e cavi di alimentazione altezza 120 cm. È possibile configurare una sospensione mixando le lampade della serie Samoi (1744.108; 1744.109; 1744.110) a fianco un esempio.

4-light suspension lamp made of powder-painted metal: soft-touch black on the outside, white on the inside. Brushed brass rod. With shifting kit and 120 cm long power supply cord. You can configure a suspension by mixing the Samoi series lamps (1744.108; 1744.109; 1744.110) as shown in the example to the side.

Hängeleuchte mit 4 Lichtern aus pulverbeschichtetem Metall: Außenfarbe schwarz soft touch, Innenfarbe weiß. Schaft aus gebürstetem Messing. Mit Dezentralisierungskit und Stromkabeln, Höhe 120 cm. Es kann eine Hängeleuchte konfiguriert werden, indem die Leuchten der Samoi-Serie (1744.108; 1744.109; 1744.110) gemischt werden. Hier ist ein Beispiel.

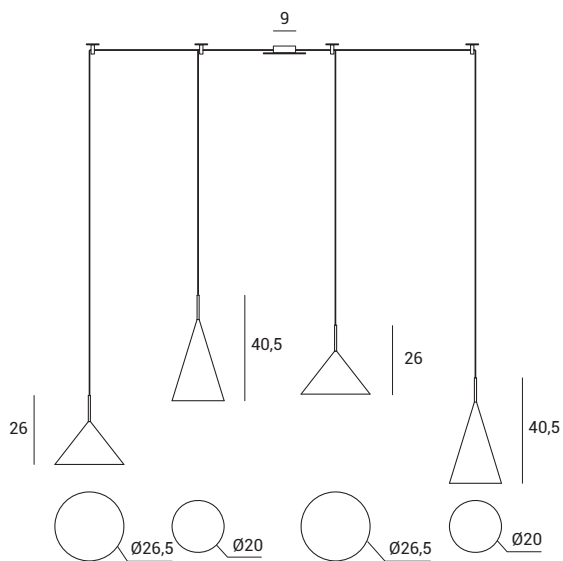

SAMOI



Source

E27 LED

Power

3 x max 40w



Lampada a sospensione a 5 luci in metallo verniciato a polvere: colore esterno nero soft touch, interno bianco. Stelo in ottone spazzolato. Dotata di Kit di decentramento e cavi di alimentazione altezza 200 cm. È possibile configurare una sospensione mixando le lampade della serie Samoi (1744.108; 1744.109; 1744.110) a fianco un esempio.

5-light suspension lamp made of powder-painted metal: soft-touch black on the outside, white on the inside. Brushed brass rod. With shifting kit and 200 cm long power supply cord. You can configure a suspension by mixing the Samoi series lamps (1744.108; 1744.109; 1744.110) as shown in the example to the side.

Hängeleuchte mit 5 Lichtern aus pulverbeschichtetem Metall: Außenfarbe schwarz soft touch, Innenfarbe weiß. Schaft aus gebürstetem Messing. Mit Dezentralisierungskit und Stromkabeln, Höhe 200 cm. Es kann eine Hängeleuchte konfiguriert werden, indem die Leuchten der Samoi-Serie (1744.108; 1744.109; 1744.110) gemischt werden. Hier ist ein Beispiel.

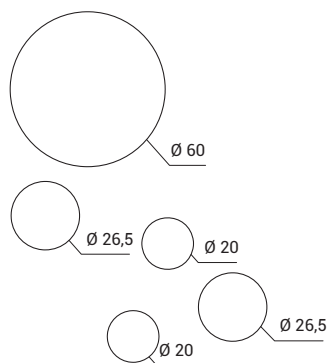
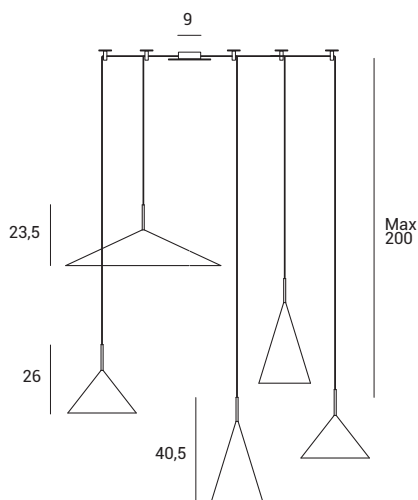

SAMOI



Source

E27 LED

Power



Lampada a sospensione a 6 luci in metallo verniciato a polvere: colore esterno nero soft touch, interno bianco. Stelo in ottone spazzolato. Dotata di Kit di decentramento e cavi di alimentazione altezza 200 cm. È possibile configurare una sospensione mixando le lampade della serie Samoi (1744.108; 1744.109; 1744.110) a fianco un esempio.

6-light suspension lamp made of powder-painted metal: soft-touch black on the outside, white on the inside. Brushed brass rod. With shifting kit and 200 cm long power supply cord. You can configure a suspension by mixing the Samoi series lamps (1744.108; 1744.109; 1744.110) as shown in the example to the side.

Hängeleuchte mit 6 Lichtern aus pulverbeschichtetem Metall: Außenfarbe schwarz soft touch, Innenfarbe weiß. Schaft aus gebürstetem Messing. Mit Dezentralisierungskit und Stromkabeln, Höhe 200 cm. Es kann eine Hängeleuchte konfiguriert werden, indem die Leuchten der Samoi-Serie (1744.108; 1744.109; 1744.110) gemischt werden. Hier ist ein Beispiel.

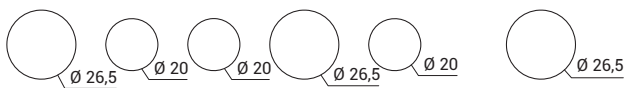
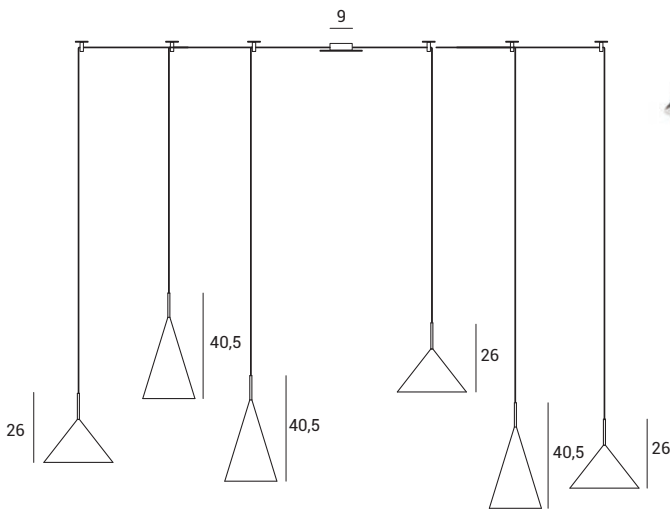

SAMOI



Source

E27 LED

Power

SAMOI

SOSPENSIONI E KIT - SUSPENSIONS AND KITS - HÄNGELEUCHTEN UND KIT

KIT per configurazione personalizzata. Serie di lampade a sospensione SAMOI a 3, 4, 5 e 6 luci.
Rosone per 3, 4, 5 e 6 luci. Cavi di alimentazione altezza 200 cm.

KIT for customized configuration SAMOI suspension lamp series with 3, 4, 5 or 6 lights.
Rosette with 3, 4, 5 and 6 lights. 200 cm long power supply cord.

KIT für die individuelle Konfiguration. Hängeleuchten-Serie SAMOI mit 3, 4, 5 und 6 Lichtern.
Rosette für 3, 4, 5 und 6 Lichter. Stromkabel, Höhe 200 cm.

FORMA/SHAPE/BILDEN

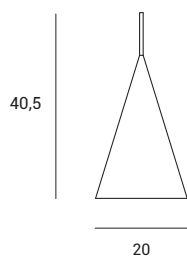

1744.110



FORMA/SHAPE/BILDEN

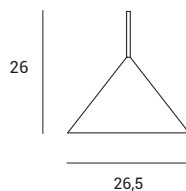

1744.109



FORMA/SHAPE/BILDEN

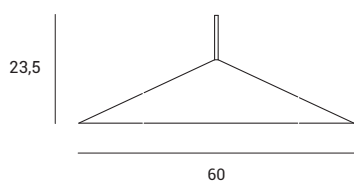

1744.108



ROSONI E KIT A SOFFITTO/ROSETTES and CEILING kit/ROSETTEN UND DECKEN-KITS

FORMA/SHAPE/BILDEN

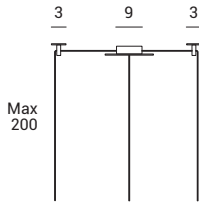

1744.M.52



FORMA/SHAPE/BILDEN

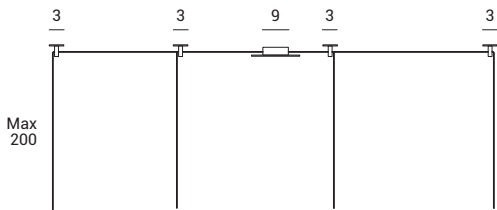

1744.M.53



FORMA/SHAPE/BILDEN

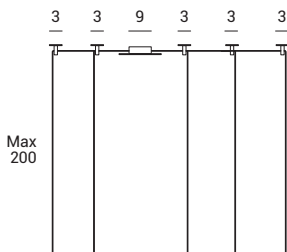

1744.M.54



FORMA/SHAPE/BILDEN

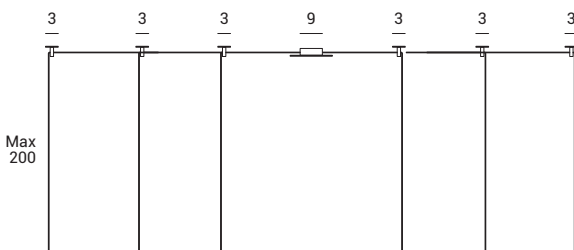

1744.M.55

